

Temposonics®

Magnetostrictive, Absolute, Non-contact
Linear-Position Sensors



R-Series Model RF Flexible Housing Option

Document Part Number
551081 Revision B

Data Sheet



Model RF flexible housing option for R-Series sensors with voltage, current, SSI, CANbus, DeviceNet, Profibus, EtherCAT® and EtherNet/IP outputs

FEATURES

- Linear, Absolute Measurement Along an Arc
- LEDs For Sensor Diagnostics
- Non-Contact Sensing Technology
- Linearity Deviation Less Than 0.02%
- Repeatability Within 0.001%
- Flexible Housing is Optional For MTS R-Series Sensors With The Following Full Range of Outputs: Voltage, Current, SSI, CANbus, DeviceNet, Profibus, EtherCAT® and EtherNet/IP
- Measuring Stroke Range: 255 mm (10 in.) to 10,060 mm (396 in.)
(Contact factory for longer stroke lengths)

BENEFITS

- Rugged Industrial Sensor
- Multi-Magnet Position Measurement: Up to 20 Positions
- 100% Field Adjustable Null And Span Setpoints
- Cost Effective, Convenient Shipping for Long Measuring Lengths

APPLICATIONS

- Hydraulic Cylinder Applications with Limited Sensor Installation Space
- Accurate Position Measurement Along an Arc
- Very Long Measurement Lengths

TYPICAL INDUSTRIES

- Fluid Power
- Steel Mills Using Long Cylinders
- Material Handling and Packaging
- Woodworking, Metalworking and Assembly Tools
- Converting Machines

Time-based Magnetostrictive position sensing principle

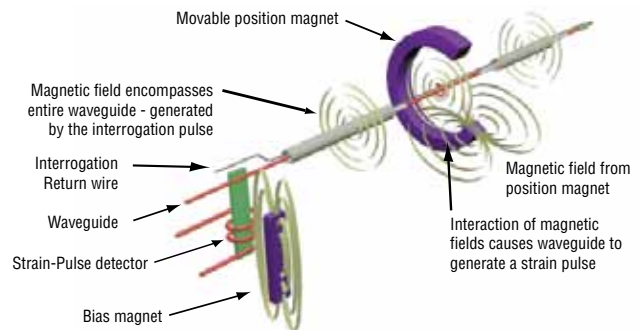

Benefits of Magnetostriction

Temposonics linear-position sensors use the time-based magnetostrictive position sensing principle developed by MTS. Within the sensing element, a sonic-strain pulse is induced in a specially designed magnetostrictive waveguide by the momentary interaction of two magnetic fields. One field comes from a moveable permanent magnet that passes along the outside of the sensor. The other field comes from an "interrogation" current pulse applied along the waveguide. The resulting strain pulse travels at sonic speed along the waveguide and is detected at the head of the sensing element.

The position of the magnet is determined with high precision and speed by accurately measuring the elapsed time between the application of the interrogation pulse and the arrival of the resulting strain pulse with a high-speed counter. The elapsed time measurement is directly proportional to the position of the permanent magnet and is an absolute value. Therefore, the sensor's output signal corresponds to absolute position, instead of incremental, and never requires recalibration or re-homing after a power loss. Absolute, non-contact sensing eliminates wear, and guarantees the best durability and output repeatability.

Sold & Serviced By:



Toll Free Phone (877) SERV098
Toll Free Fax (877) SERV099
www.electromate.com
sales@electromate.com

Product Overview and Specifications

Product overview

MTS offers the Model RF Flexible housing as an option with our R-Series family of extremely robust, highly accurate, linear-position sensors.

Constructing a R-Series sensor with the RF flexible housing results in a flexible style sensor that offers trouble-free performance in applications that require very long stroke lengths and linear measurements on an arc.

The Model RF flexible sensors are available in all R-Series sensor outputs including analog, serial, digital, and bus interfaces. Standard stroke lengths for the sensor are up to 10 meters (396 in.) and for special applications, longer lengths are available by consulting the factory.

Flexible sensors incorporate the Temposonics SE (Sensing Element) technology that is the same building block all MTS sensor models use. The SE is housed in a fluoroelastomer coated stainless steel housing that is flexible and can be bent in an arc to an 8 inch minimum bend radius.

Most operating parameters are identical to their rigid cousins. Model RF sensors are recommended for long-length applications because they are simply coiled inside a 40-inch diameter box for shipping, which simplifies logistics and handling.

The model RF sensor can easily bend around corners or obstacles and provides a simple solution for applications where installation space is too confined, or has limited access, making installation or replacement too difficult and costly for a standard rigid type sensor.

Output options

The Model RF Flexible Housing option is available for R-Series Sensors with voltage, current, SSI, CANbus, DeviceNet, Profibus, EtherCAT and EtherNet/IP outputs.

Important specification notes:

1. For R-Series model specific specifications, consult the individual R-Series data sheets applicable to the sensor output(s) being used.
2. All sensors constructed with the flexible housing have their specifications measured while laying flat.

Product specifications

Parameters	Specifications
OUTPUT	
Measured output variables:	Position, velocity, simultaneous multi-position and velocity measurements. (Measured output variables depend on the complete sensor model used.)
Resolution:	Output dependent
Update times:	Output dependent
Linearity deviation:	< ± 0.02% full stroke (minimum ± 100 µm) Linearity Correction Option (LCO) available for some R-Series models
Repeatability:	< ± 0.001% full stroke (minimum ± 2.5 µm)
Hysteresis:	< 4 µm, 2 µm typical
Outputs:	Voltage, current, SSI, CANbus, DeviceNet, Profibus, EtherCAT and EtherNet/IP
Measuring range:	255 to 10,060 mm (10 to 396 in.) (Contact factory for longer stroke lengths)
ELECTRONICS	
Operating voltage:	+24 Vdc nominal: -15% or +20% Polarity protection: up to -30 Vdc Over voltage protection: up to 36 Vdc Current drain: Output dependent Dielectric withstand voltage: 500 Vdc (DC ground to machine ground)
ENVIRONMENTAL	
Operating conditions:	Operating temperature: -40 °C (-40 °F) to +75 °C (+167 °F) Relative humidity: 90% no condensation
EMC test:	Emissions: IEC/EN 50081-1 Immunity: IEC/EN 50082-2 IEC/EN 61000-4-2/3/4/6, level 3/4 criterion A, CE qualified
Shock rating:	100 g (single hit)/ IEC standard 68-2-27 (survivability)
Vibration rating:	5 g/10 to 2000 Hz, IEC standard 68-2-6 (operational)
WIRING	
Connection type:	Connector or integral cable (output dependent)
ROD STYLE SENSOR (MODEL RF)	
Electronic head:	Aluminum die cast housing with diagnostic LED display (LEDs located beside connector/cable exit)
Sensor stroke:	Flexible stainless-steel pipe (PTFE plastic coated), minimum bend radius 200 mm (8 in.)
Sealing:	IP 30 (IP 67 or IP 68 rating when installed inside the optional 1/2 inch O.D. pressure housing pipe)
Mounting:	Any orientation. Threaded flange M18 x 1.5 or 3/4 - 16 UNF-3A
Magnet types:	Ring magnet or open-ring magnet or block magnet

Sold & Serviced By:



Toll Free Phone (877) SERV098
Toll Free Fax (877) SERV099
www.electromate.com
sales@electromate.com

Model RF flexible housing option dimension references

R-SERIES SENSOR WITH MODEL RF FLEXIBLE HOUSING OPTION

Drawing is for reference only, contact applications engineering for tolerance specific information.

Notes:

- Total sensor length tolerances are:
+8 mm (0.3 in.)/-5mm (0.2 in.) up to 7600 mm (300 in.) stroke length.
+15 mm ((0.6 in.)/-5 mm (0.2 in.) over 7600 mm (300 in.) stroke length.
- Tolerances of total length do not influence the measuring stroke length.

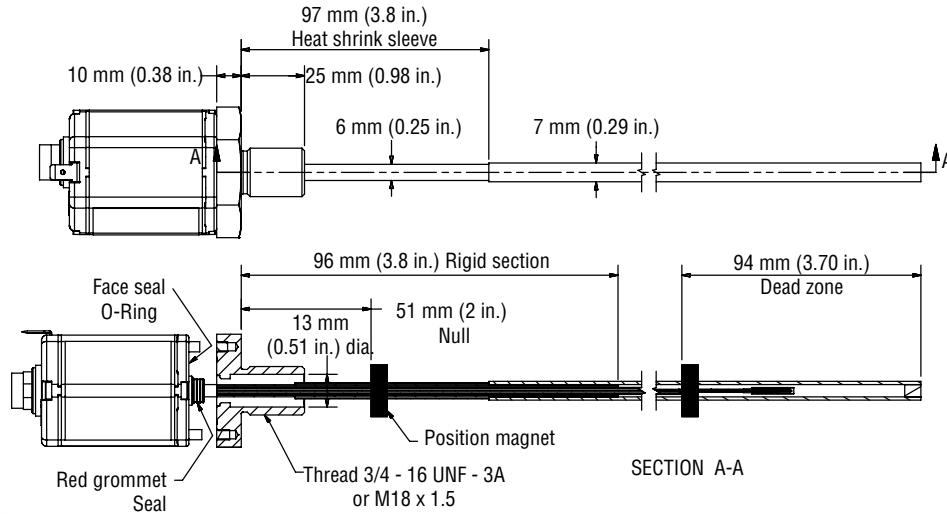

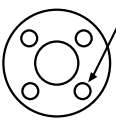

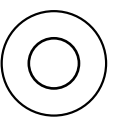

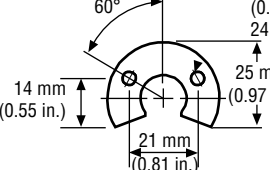

Figure 1. R-Series Model RF flexible housing dimension reference

Standard magnet selections (Model RF)

POSITION MAGNET SELECTIONS (Drawing dimensions are for reference only)

Magnet and magnet dimensions	Description	Part number
  <p>4 Holes Each 4.3 mm (0.17 in.) dia. 90° apart on 24 mm (0.94 in.) dia.</p>	<p>Standard ring magnet I.D.: 13.5 mm (0.53 in.) O.D.: 33 mm (1.3 in.) Thickness: 8 mm (0.3 in.) Operating temperature: - 40 °C to 100 °C</p>	201542-2
 	<p>Ring magnet I.D.: 13.5 mm (0.53 in.) O.D.: 25.4 mm (1 in.) Thickness: 8 mm (0.3 in.) Operating temperature: - 40 °C to 100 °C</p>	400533
  <p>2 Holes Each 4.3 mm (0.17 in.) dia. on 24 mm (0.94 in.) dia.</p> <p>60° 14 mm (0.55 in.) 25 mm (0.97 in.) 21 mm (0.81 in.)</p>	<p>Open-ring magnet, Style M I.D.: 13.5 mm (0.53 in.) O.D.: 33 mm (1.3 in.) Thickness: 8 mm (0.3 in.) Operating temperature: - 40 °C to 100 °C</p> <p>This magnet may influence the sensor performance specifications for some applications.</p>	251416-2

Model RF Flexible Housing Option for R-Series Sensors
Dimension and Magnet Selection References

POSITION MAGNET SELECTIONS (Drawing dimensions are for reference only)

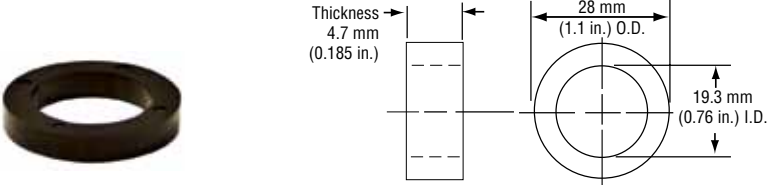
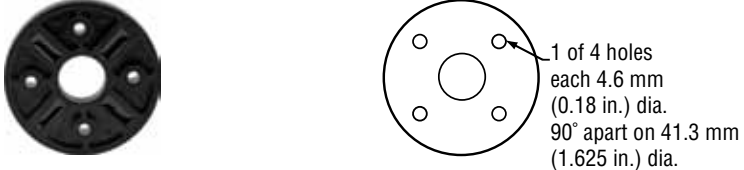
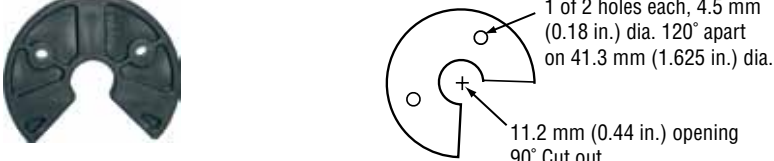
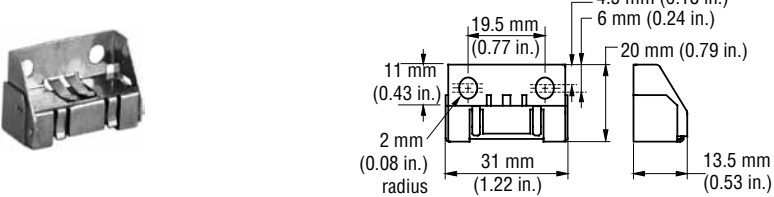
Magnet and magnet dimensions dimensions	Description	Part number
	<p>Ring magnet I.D.: 19.3 mm (0.76 in.) O.D.: 28 mm (1.1 in.) Thickness: 4.7 mm (0.185 in.) Operating temperature: - 40 °C to +100 °C</p>	400424
	<p>Large ring magnet I.D.: 19.05 mm (0.75 in.) O.D.: 63.5 mm (2.49 in.) Thickness: 9.5 mm (0.375 in.) Operating temperature: - 40 °C to +75 °C</p>	201554
	<p>Large ring magnet I.D.: 15.9 mm (0.63 in.) O.D.: 63.3 mm (2.49 in.) Thickness: 9.5 mm (0.38 in.) Operating temperature: - 40 °C to +75 °C</p>	201553
	<p>Block magnet, Style L I.D.: 19.5 mm (0.77 in.) Width: 31 mm (1.22 in.) Thickness: 13.5 mm (0.53 in.) Operating temperature: - 40 °C to +75 °C</p> <p>This magnet may influence the sensor performance specifications for some applications.</p>	252887

Sensor mounting and Installation references

R-SERIES MODEL RF SENSOR MOUNTING AND INSTALLATION *Flexible installation in any position!*

The model RF flexible sensor housing can be mounted to provide straight or curvilinear measurements. The sensor's flexible housing requires supports or anchoring to maintain proper alignment between the sensor rod and the magnet. Without proper alignment, the sensor's output signal can be interrupted or lost.

A hex flange comes mounted on the sensor head having either U.S. customary threads (3/4 - 16 UNF inches) or metric threads (M18 x 1.5). The flange is secured to the sensor head by 2 metric screws (M4 x 59 mm, 2.5 mm hex socket head). The flange can be used, or removed, to best accommodate the installation requirements. If the sensor is mounted without the flange, the red grommet seal can be cut off to provide a flush mounting surface for the sensor's face seal O-Ring (shown in 'Figure 1' on page 3 and 'Figure 2' below).

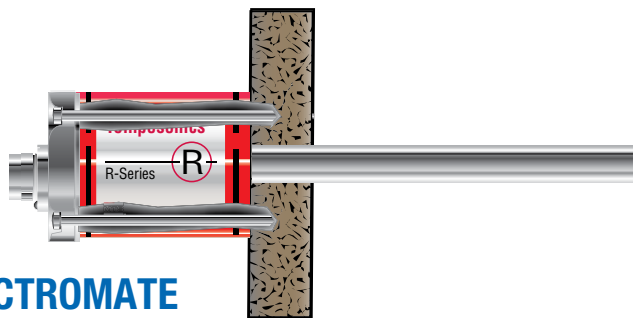

**Model RF Flexible Housing Option for R-Series Sensors
Magnet Selection and Installation References**

Figure 2. Installation example for flush mounting with red grommet seal removed.

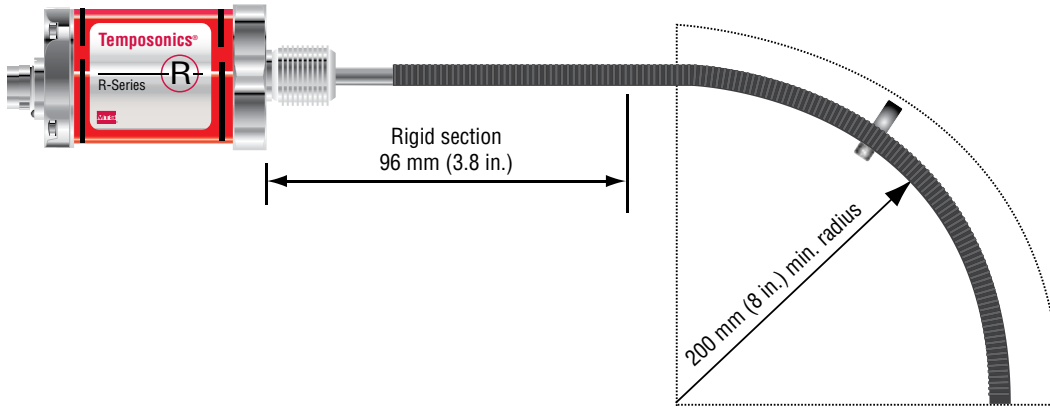

Figure 3. Installation example showing minimum bend radius for curvilinear measurements.

Most applications require that the RF flexible sensor housing be supported, such as, placed inside a guide pipe made of non-ferrous material, straight or bent to the desired shape.

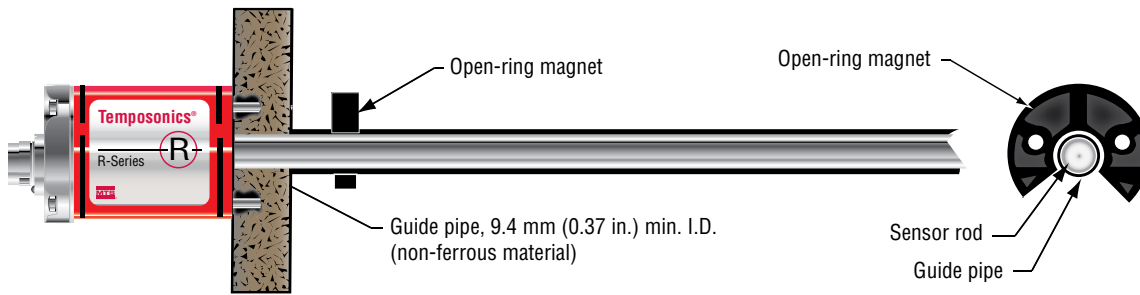

Figure 4. Installation example using non-ferrous guide pipe (customer supplied).

When installed inside the MTS half-inch O.D. pressure housing pipe, the RF flexible sensor housing is suitable for use in hydraulic cylinders, and can simplify installation where installation or mounting space is limited (see 'Figure 7').

Half inch O.D. pressure pipe and flange (Optional)

PIPE AND FLANGE SELECTIONS

The half inch O.D. pressure pipe with flange is designed specifically for R-Series sensors with the model RF flexible housing option. The pressure pipe and flange provide protection from high pressures, as found in hydraulic cylinders, up to 5,000 psi static, 10,000 psi spike. For large cylinders, using the half-inch O.D. pressure pipe requires a larger gun-drilled bore in the piston head/rod assembly. Typically, a 0.75 inch bore is used to match the I.D. of the ring magnet used (e.g. part no.: 201554 or part no.: 400424).

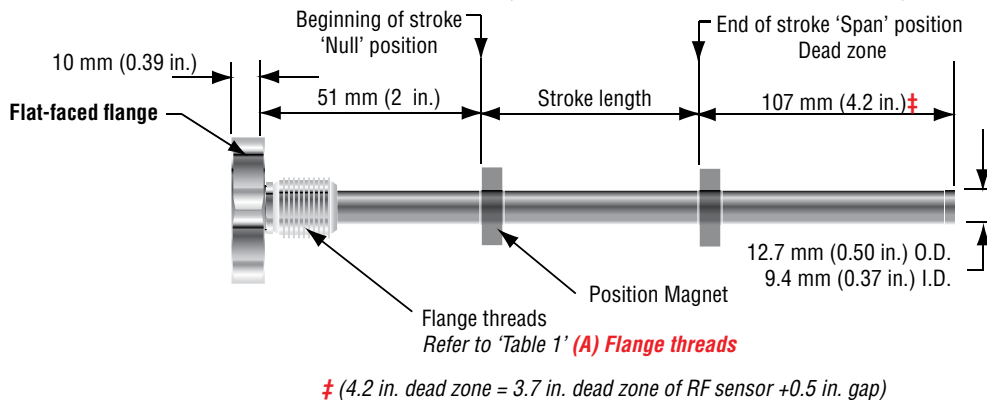

Figure 5. Style 'HL' pressure pipe (flat-faced flange shown with U.S. customary threads)

**R-Series Model RF Flexible Housing Option
Pressure Pipe and Flange Selections**

HALF INCH O.D. PRESSURE HOUSING PIPE AND FLANGE SELECTIONS (CONTINUED)

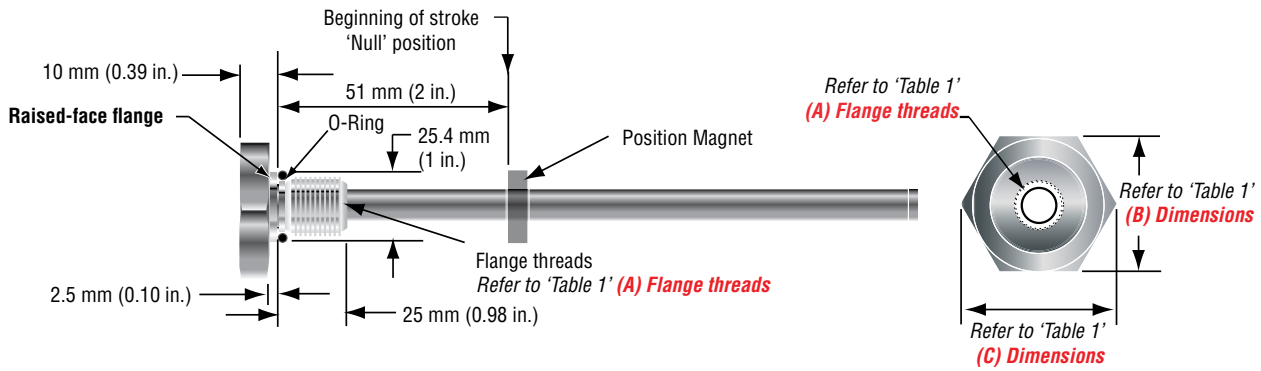

Figure 6. Style 'HP' pressure pipe (raised-face flange shown with U.S. customary threads)

FLANGE TYPE	DESCRIPTION	(A) FLANGE THREADS	(B) DIMENSIONS	(C) DIMENSIONS
HP	US customary threads with raised-face flange	3/4" - 16 UNF-3A	1.75 in.	2 in.
HL	US customary threads with flat-faced flange	3/4" - 16 UNF-3A	1.75 in.	2 in.
HD	Metric threads with flat-faced flange	M18 x 1.5	46 mm	53 mm

Table 1. Flange options and specifications

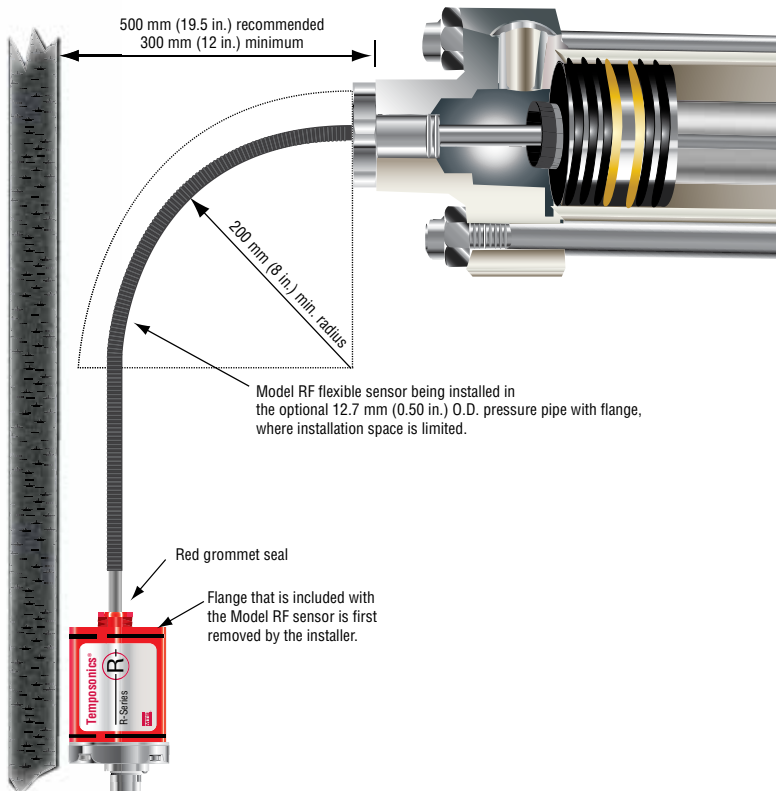

Figure 7. Installation example using optional 12.7 mm (0.50 in.) O.D. pressure pipe inside hydraulic cylinder

**R-Series Model RF Flexible Housing Option
Ordering Information**

H									
1	2	3	4	5	6	7			

HALF INCH O.D. PRESSURE PIPE AND FLANGE STYLE _____ =

H	
---	--

1-2

HL = US customary threads, flat-faced flange and 1/2 inch pressure pipe **HP** = US customary threads, raised-faced flange and 1/2 inch pressure pipe, **HD** = Metric threads, flat-faced flange and 1/2 inch pressure pipe

STROKE LENGTH _____ =

--	--	--	--	--	--

3-7

----- **M** = Millimeters
(Encode in 5 mm increments)

----- **U** = Inches and tenths
(Encode in 0.1 in. increments)

Stroke Length Notes:

1. Half inch O.D. pressure pipe and flange stroke range = 255 mm (10 in.) to 5840 mm (230 in.)
2. Contact factory for longer lengths.

Ordering examples:

HL0120U = 1/2 inch O.D. pressure pipe with flat-faced flange, US customary threads, for a 12.0 inch stroke length
HD1000M = 1/2 inch O.D. pressure pipe with flat-faced flange, metric threads, for a 1000 mm stroke length

**Ordering Information
R-Series Model RF Flexible Housing Option**

R	F								
1	2	3	4	5	6	7	8	9	

To complete the sensor model number, consult the specific ordering information page for the R-Series model you need.

R-SERIES HOUSING MODEL _____ =

R	F
---	---

1-2

RF = Flexible style
Magnet must be ordered separately.

FLANGE TYPE _____ =

--

3

S = US customary threads, flat-faced flange **M** = Metric threads, flat-faced flange

STROKE LENGTH _____ =

--	--	--	--	--	--

4-9

----- **M** = Millimeters
(Encode in 5 mm increments)

----- **U** = Inches and tenths
(Encode in 0.1 in. increments)

Stroke Length Notes:

1. Flexible housing style sensor (model RF) stroke range = 255 mm (10 in.) - 10,060 mm (396 in.)
2. Contact factory for longer lengths.

Ordering Examples:

RFS**03937U**D701S1B1100 = 393.7 in. stroke length for RF sensor with SSI output
 RFM**10000M**D631P102 = 10,000 mm stroke length for RF sensor with Profibus output

Document Part Number: 551081, Revision B 10/11



MTS and Temposonics are registered trademarks of MTS Systems Corporation.
 All other trademarks are the property of their respective owners.
 Printed in USA. Copyright © 2011 MTS Systems Corporation. All Rights Reserved in all media.

